

Specification

Integrated Furniture Lighting

LS2013



LS2013



Features

DLS1.0, a special local auxiliary lighting system, can be widely used in various interior decoration scenarios and local light spaces. A touch of auxiliary decorative lighting in addition to the basic lighting creates different atmospheres and visual enjoyment.

Embellish life with light that follows you whenever you go.

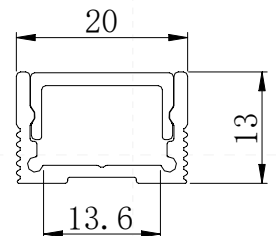

- 1、 "Dots-free"lighting
Perfect homogenous lighting.
- 2、 Various diffuser options
Several options of diffusers, In various shapes and light distribution plans Complete with everything needed
- 3、 "Two" end caps
Two options of end cap for two ways of wire outgoing, Close-fitting design without screws makes installation much easier
- 4、 Various installation methods
A wide range of installation accessories wider applications
- 5、 "One" cut
Consistent length between diffuser and profile
- 6、 Smart control for unlimited possibilities
Perfectly match the profiles like customized, Control by hand sweep or touching

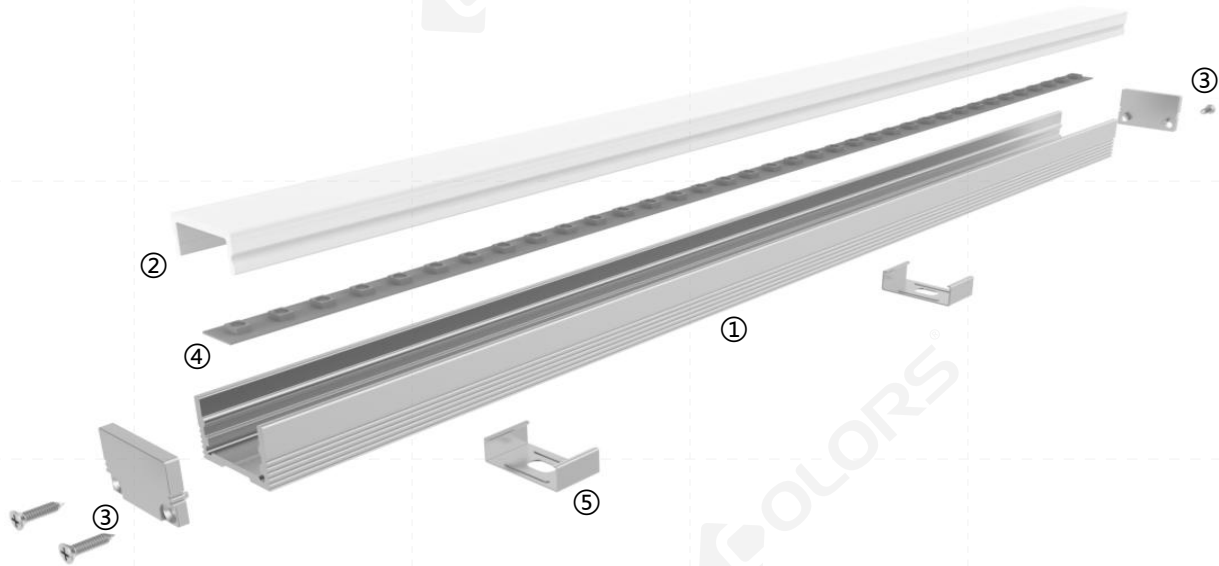

Details







Standard Configuration

Picture	Item	Parameter	Model
	① Profile & Carrier	Material: AL6063-T5 Profile weight: 0.473kg/2.5m Size: L2500*W20*H13mm Surface processing: Anodizing	/
	② Cover	Type: Frosted diffuser Material: PC Light transmittance: 60% Size: L2500*W16.7*H7.8mm (shrink) 0.8mm/m when the temperature rises (drops) 10°C.	/
	③ End caps	Size: L20*W13*H4.5mm	EC-LS2013



Optional Accessories

Picture	Item	Parameter	Model
	②Microprism diffuser	Type: Microprism diffuser Material: PC Light transmittance: 65% Size: L2500*W16.7*H7.8mm (shrink) 0.8mm/m when the temperature rises (drops) 10°C.	CV-LR2013
	②Black Microprism	Type: Black Microprism Material: PC Light transmittance: 7% Size: L2500*W16.7*H7.8mm (shrink) 0.8mm/m when the temperature rises (drops) 10°C.	CV-LR2013
	③End cap with hole	Size: L20*W13*H4.5mm	EC-LS2013
	④FPC strip D6280-24V-10mm	Material: FPC, CCT: 2700/3000/4000/6000K; Ra > 90; Voltage:24V; Power: 15W/m; Lumen: 1508Lm/m; PCB width: 10mm; Minimum cut: 50mm;	D6280-24V- 10mm
	⑤Clips	Size: L21.8*W12*H6.4mm	CP-08

Optical Parameter

The testing result of 1M luminaire (with " D6280-24V-10mm " and diffuser)

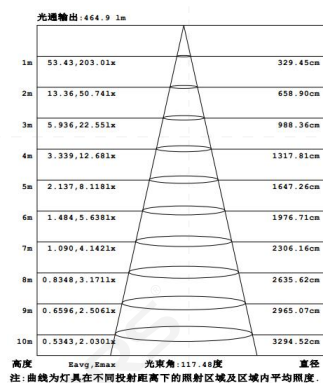
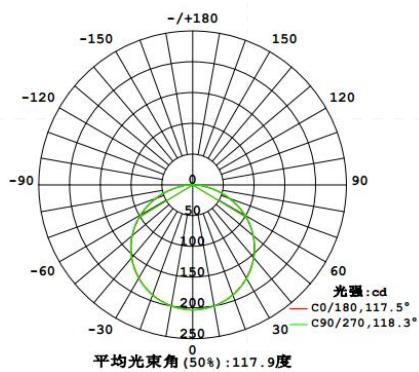

Package

Mode 1 :

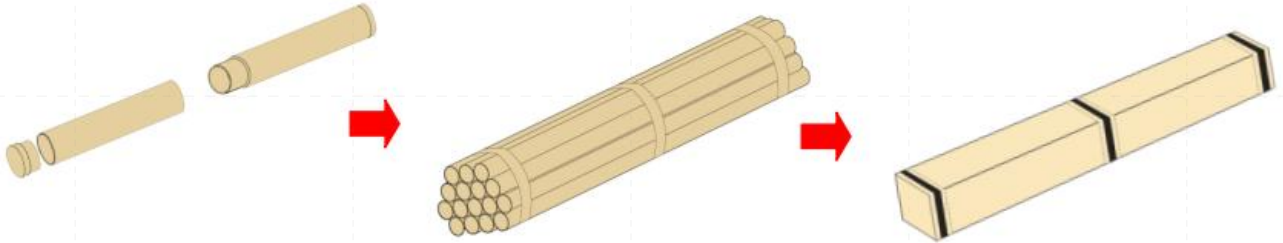

Mode 2 :

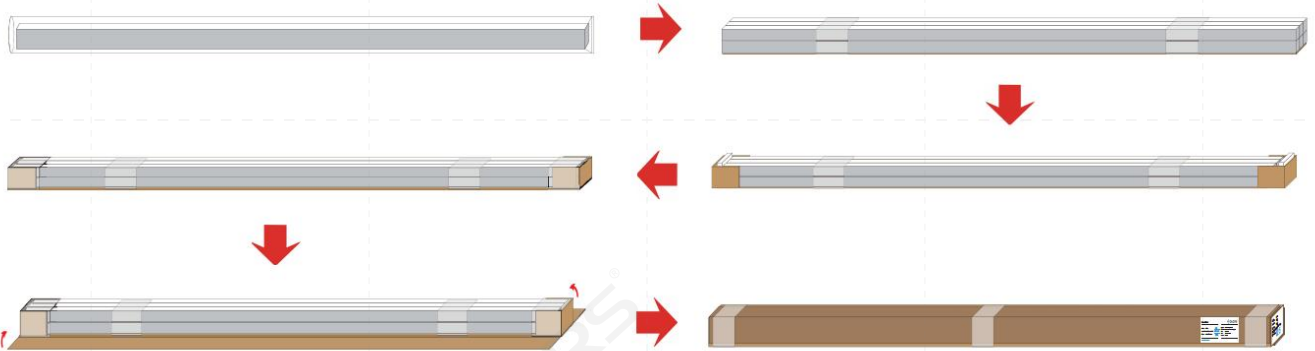

Components	Packaging material	Size(mm)	NW(kg)	GW(kg)	Content
Single piece	Hat box	Φ31mm*2580mm	0.65	1.1	1pcs/box
Whole bundle	Hat box	2580*250*165mm	21.45	38.3	33pcs/box
Whole box packaging	Paper box	2580*95*100mm	9.75	12.75	15pcs/box

